



VANITI  HOUSE  
BATHROOMS DESIGNED TO CARE

## LIVING CONCEPTS

A flexible, modular range designed to help you create a fully customised combination of bathroom support rails.



## INDEX

- INTRODUCTION
- LIVING SINGLE GRAB BAR
- LIVING DOUBLE GRAB BAR
- LIVING V SHAPED BAR (LEFT & RIGHT)
- LIVING CORNER BAR
- LIVING L SHAPED SHOWER BAR (LEFT & RIGHT)
- LIVING SHOWER BAR
- LIVING HINGED GRAB BAR
- LIVING FIXING CONNECTIONS
- LIVING ACCESSORIES
- WARRANTY & CARING FOR YOUR PRODUCT

THE SUPPORT YOU NEED,  
THE WAY YOU WANT IT



Prices quoted are including VAT.  
Prices are subject to change without prior notice.  
Please verify current prices and stock availability before ordering.  
E&OE | To the best of Vaniti House's knowledge, the information  
contained in this document is correct.

# INTRO

---

At Vaniti House, we believe support and style should go hand in hand. The Living Concept Collection has been created with flexibility in mind – giving you the freedom to design support rails that suit your space, your needs, and your style.

Beautifully designed grab bars are hard to come by, and this range fills that gap by combining safety and style.

Whether used at home, in hospitality, or in professional projects, the collection makes it possible to create bathrooms that are supportive, adaptable, and beautiful.

Our goal is to help shape bathrooms that offer care, comfort, and confidence, without compromising on design.



# LIVING CONCEPTS COLLECTION

---

Discover the Living Concept Collection from Vaniti House – a caring range of flexible modules that lets you create your own customised combination of bathroom support rails.

The collection includes both modular systems and individual rails, giving you endless possibilities to design a bathroom that's supportive, safe, and beautifully personal.

Each element can be adapted with ease, making it simple to match your needs while keeping the look of your bathroom just the way you like it.

With the grab bar series, you can use them on their own or link them together into a full system – giving you the freedom to design support that grows with you.



LIVING CONCEPTS

# SINGLE GRAB BAR

LIVING GRAB BAR 400MM

Product code  
FK810

Price Incl. VAT  
R3 267,00



## LIVING Grab Bar, Short

Chromed Stainless Steel  
Length 400 mm  
Diameter 32 mm  
Weight 1273 g

A : 400 mm B: 25 mm C: 90 mm

The Living Concept Collection has been rigorously tested in accordance with SS-ISO 17966:2016, section 23.7.3, ensuring high standards for assistive products in personal hygiene.

Testing performed by RISE  
Research Institutes of Sweden.

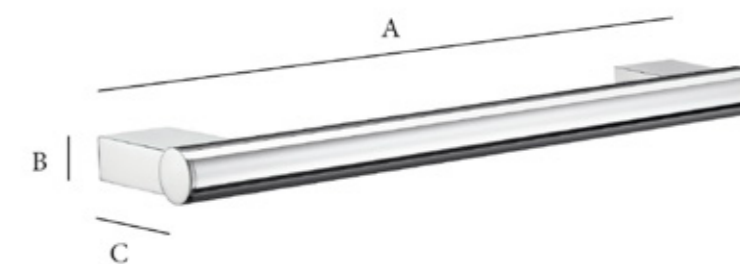

LIVING CONCEPTS

# DOUBLE GRAB BAR

LIVING DOUBLE GRAB BAR 900MM

Product code  
FK811

Price Incl. VAT  
R5 787,00



LIVING Grab Bar, Long

Chromed Stainless Steel  
Length 900 mm  
Diameter 32 mm  
Weight 1750 g

**A** : 900 mm **B** : 25 mm **C** : 90 mm

The Living Concept Collection has been rigorously tested in accordance with SS-ISO 17966:2016, section 23.7.3, ensuring high standards for assistive products in personal hygiene.

Testing performed by RISE  
Research Institutes of Sweden.

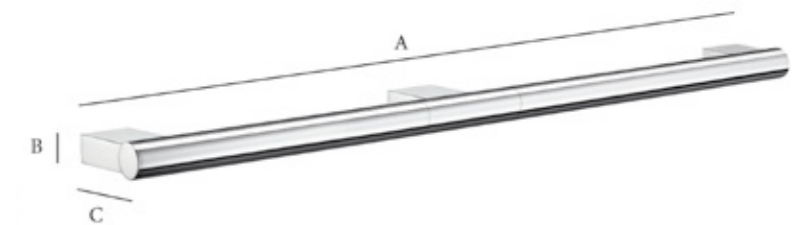

LIVING CONCEPTS

# V SHAPED BAR

LIVING V SHAPED GRAB BAR

Product code  
FK812 (right)  
FK813 (left)

Price Incl. VAT  
R5 762.00



LIVING Grab Bar V-shape,  
Left & Right

Chromed Stainless steel  
Length 400 x 400 mm  
Weight 2050 g

A: 400 mm B: 730 mm C: 90 mm  
D: 25 mm E: 700 mm F: 310 mm

The Living Concept Collection has been rigorously tested in accordance with SS-ISO 17966:2016, section 23.7.3, ensuring high standards for assistive products in personal hygiene.

Testing performed by RISE  
Research Institutes of Sweden.

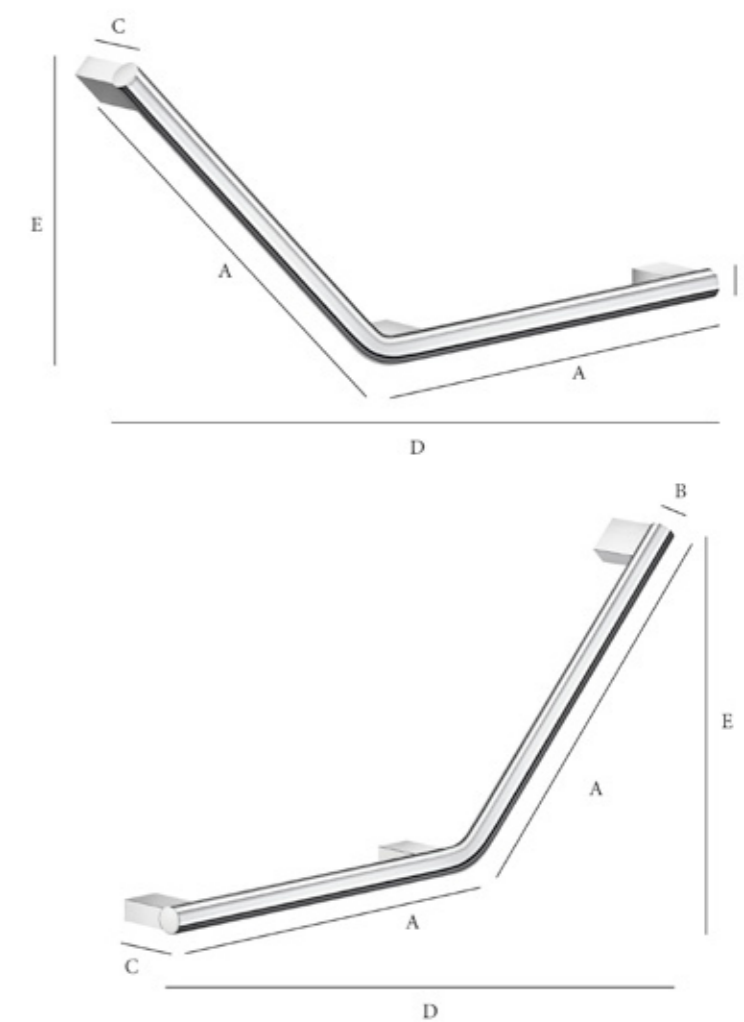

LIVING CONCEPTS  
**CORNER  
BAR**

CORNER GRAB BAR 750MM

Product code  
FK815

Price Incl. VAT  
R7 297,00



LIVING Corner Grab Bar

Chromed Stainless steel  
730 x 730 mm  
Weight 2953 g

**A** : 790 mm **B**: 25 mm **C**: 90 mm

The Living Concept Collection has been rigorously tested in accordance with SS-ISO 17966:2016, section 23.7.3, ensuring high standards for assistive products in personal hygiene.

Testing performed by RISE  
Research Institutes of Sweden



LIVING CONCEPTS  
**L SHAPED  
SHOWER  
BAR**

L SHAPED SHOWER BAR 530MM

Product code  
FK814 (left)  
FK816 (right)

Price Incl. VAT  
R8 912,00

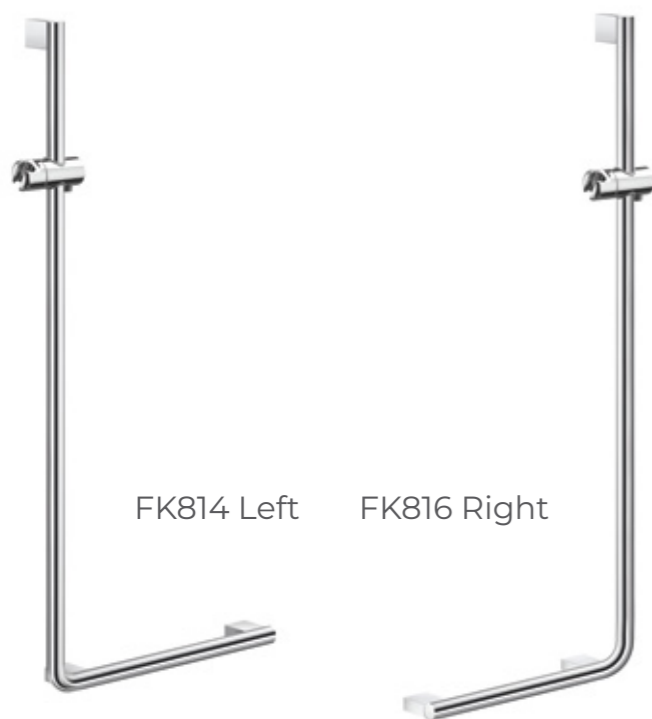

LIVING Shower Bar, L-shaped  
Right & left

Chromed Stainless steel  
1230 x 530 mm  
Weight 3200 g

**A:** 1,230 mm **B:** 530 mm **C:** 90 mm

The Living Concept Collection has been rigorously tested in accordance with SS-ISO 17966:2016, section 23.7.3, ensuring high standards for assistive products in personal hygiene.

Testing performed by RISE  
Research Institutes of Sweden



LIVING CONCEPTS  
**SHOWER  
BAR**

SHOWER BAR 1160MM

Product code  
FK817

Price Incl. VAT  
R8 912,00

FK8171 - End caps  
Price Incl. VAT  
R350,00

These caps will be used if no  
additional rails being used



LIVING Shower Bar

The shower rail serves as an ideal foundation for creating a customized support system with grab bars that suit both your bathroom layout and personal needs.

It also features a convenient hand shower holder, which can be easily adjusted to your preferred height — simply press the button and slide it into place.

Chromed Stainless steel  
Height: 1160 mm  
Diameter: 32 mm  
A: 1,160 mm B: 32 mm C: 90 mm  
Weight 2677 g

The Living Concept Collection has been rigorously tested in accordance with SS-ISO 17966:2016, section 23.7.3, ensuring high standards for assistive products in personal hygiene.

Testing performed by RISE  
Research Institutes of Sweden



LIVING CONCEPTS

# HINGED GRAB BAR

FOLDABLE

Product code  
FK840

Price Incl. VAT  
R13 544.00



## LIVING Foldable Grab bar

Chromed Stainless steel  
Length 700 mm  
Wall plate: 100 x 230 mm  
Pipe diameter 32 mm  
Load capacity 150kg

Toilet roll holder available **FK855**

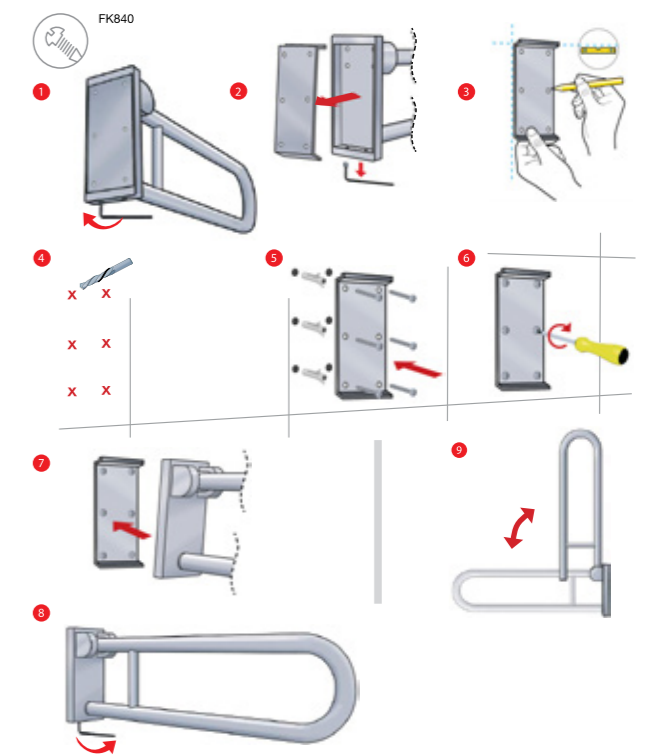

# FIXING CONNECTIONS

## FIXING POINT 400MM



LIVING Fixing Point for Grab bar, Short  
Chromed Stainless steel  
Length 400 mm  
Weight 913 g  
A: 400 mm B: 32 mm C: 50 mm D: 90 mm  
Product code: FK820  
Price Incl. VAT  
R2 214,00

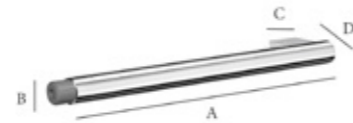

## FIXING POINT 600MM



LIVING Fixing Point for Grab bar, Long  
Chromed Stainless steel  
Length 600 mm  
Weight 1128 g  
A: 600 mm B: 32 mm C: 50 mm D: 90 mm  
Product code: FK821  
Price Incl. VAT  
R3 027,00



## CONNECTION BAR 400MM



LIVING Connection bar for Grab bar, Straight  
Chromed Stainless steel  
Length 400 mm  
Weight 670 g  
A: 400 mm B: 32 mm  
Product code: FK835  
Price Incl. VAT  
R1 298,00

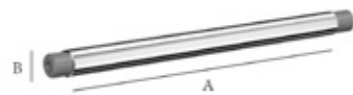

## CONNECTION T-SHAPE



LIVING Connection T-shape for Grab bar  
Chromed Stainless steel  
Length 100 mm  
Weight 555 g  
A: 100 mm B: 32 mm C: 50 mm D: 90 mm  
Product code: FK830  
Price Incl. VAT  
R1 298,00

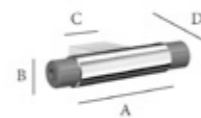

The Living Concept Collection has been rigorously tested in accordance with SS-ISO 17966:2016, section 23.7.3, ensuring high standards for assistive products in personal hygiene. Testing performed by RISE – Research Institutes of Sweden.

# FIXING CONNECTIONS

## CONNECTION L SHAPE



LIVING Connection L-shape for Grab bar, right & left  
Chromed Stainless steel  
130 x 130 mm  
Weight 700 g  
A: 400 mm B: 32 mm C: 50 mm D: 90 mm  
Product code: FK831 (right) FK833 (left)  
Price Incl. VAT  
R1 652,00

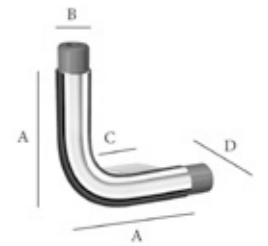

## CORNER CONNECTION



LIVING Corner Connection for Grab bar  
Chromed Stainless steel  
130 x 130 mm  
Weight 1183 g  
A: 130 mm B: 32 mm C: 50 mm D: 90 mm  
Product code: FK832  
Price Incl. VAT  
R1 652,00

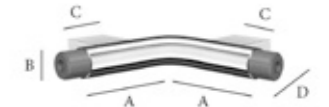

## FIXING POINT

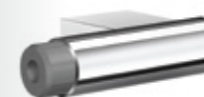

LIVING Connection T-shape for Grab bar  
Chromed Stainless steel  
Length 100 mm  
Weight 657 g  
A: 100 mm B: 32 mm C: 50 mm D: 90 mm  
Product code: FK834  
Price Incl. VAT  
R1 462,00

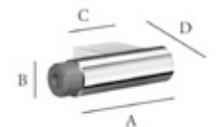

The Living Concept Collection has been rigorously tested in accordance with SS-ISO 17966:2016, section 23.7.3, ensuring high standards for assistive products in personal hygiene. Testing performed by RISE – Research Institutes of Sweden.

LIVING CONCEPTS  
**ACCESSORIES**



**LIVING Basket for shower riser rail**  
Polished Chrome  
250 x 103 mm  
Suitable for shower riser rail with diameter 32 mm

Product code: FK856  
**Price Incl. VAT**  
**R3 906,00**



**LIVING Hook for Grab Bar**  
Polished Chrome.  
Compatible with all Grab Bars with a diameter of 32 mm  
Height 82 mm

Product code: FK851  
**Price Incl. VAT**  
**R1 419,00**



**LIVING Bathroom Shelf for Grab Bar**  
Polished Chrome.  
Length 365 mm. Height 60 mm. Depth 58 mm.

Product code: FK850  
**Price Incl. VAT**  
**R2 564,00**



**LIVING Toilet Roll Holder for Grab Bar**  
Polished Chrome.  
Can be mounted on all Grab Bars with a diameter of 32 mm  
Length 125 mm. Height 105 mm.

Product code: FK855  
**Price Incl. VAT**  
**R1 812,00**

The Living Concept Collection has been rigorously tested in accordance with SS-ISO 17966:2016, section 23.7.3, ensuring high standards for assistive products in personal hygiene. Testing performed by RISE – Research Institutes of Sweden.

LIVING CONCEPTS  
**ACCESSORIES**



**LIVING Footrest, corner**  
Chromed Stainless steel.  
Length 293 mm

Product code: FK841  
**Price Incl.VAT**  
**R2 086,00**



**OUTLINE LITE Wall-mounted bin 3L**  
Available in stainless steel & black.  
Height 200 mm. Width 220 mm. Depth 160 mm  
Weight 1023 g  
Black polypropylene thermoplastic easy clean inner liner.  
Includes brackets for wall/unit/door.

A: 200 mm B: 220 mm C: 160 mm



Product code: FK669 (Chrome) FB669 (Black)  
**Price Incl. VAT**  
**R1 608,00**

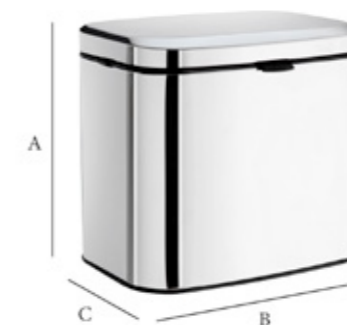

The Living Concept Collection has been rigorously tested in accordance with SS-ISO 17966:2016, section 23.7.3, ensuring high standards for assistive products in personal hygiene. Testing performed by RISE – Research Institutes of Sweden.

LIVING CONCEPTS  
**SHOWER  
SEAT**

FOLDABLE

Product code  
FK404 (WE Bianco)  
FK414 (DD Graphite)

Price Incl. VAT  
R11 928,00



FK404



FK414



LIVING Folding Wall-mounted Shower Seat

Chromed Zinc/Aluminium  
White seat  
Fixations included for solid brick wall  
Seat L 371 x W 320 mm

A: 371 mm B: 377 mm C: 210 mm D: 60 mm  
Weight 3532 g

**Finishes**



WE Bianco Segnale  
(Signal White)

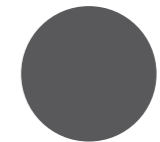

DD Grafite  
(Graphite)

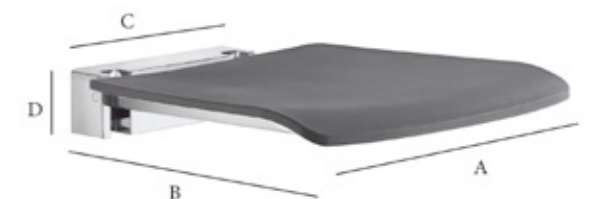

# THANK YOU FOR JOINING US ON OUR INCLUSIVE JOURNEY

*With Love*



KATHRYN HAUGE

Co-Founder  
& Business  
Development



LEIGH-ANNE REABOW

Co-Founder  
& Creative Director

[www.vanitihouse.com](http://www.vanitihouse.com) | [info@vanitihouse.com](mailto:info@vanitihouse.com)

SOUTH AFRICA | +27 (0) 82 375 2555

UNITED KINGDOM | +44 (0) 758 533 9198





LIVING CONCEPTS

# 10 YEAR WARRANTY

The Living Concepts support rails are crafted to the highest standards, with meticulous attention to material selection, manufacturing quality, design, and functionality. The support rails are covered by a 10-year warranty, with the exception of the pedal bins, which carry a 5-year warranty.

Should a functional defect arise within the warranty period, and upon presentation of valid proof of purchase, the product will be repaired or replaced with an equivalent item. If repair or replacement is not possible, a refund of the purchase price will be issued. The customer must notify Vaniti House ([info@vanitihouse.com](mailto:info@vanitihouse.com)) in writing as soon as the defect is identified.

This warranty applies solely to the product itself and does not cover any consequential or indirect damages. The warranty remains valid provided the defect is not caused by misuse, neglect, or abnormal use.

## CARING FOR YOUR PRODUCT

To maintain the enduring quality and finish of your Living Concept product, we recommend regular cleaning using a soft microfiber cloth and lukewarm water. If needed, a mild soap solution may be used. Always dry the surface thoroughly after cleaning to prevent water marks or limescale build-up.

Avoid abrasive cleaners, scouring pads, steel wool, or harsh sponges, as these may scratch or damage the surface finish.

## INSTALLATION

The rails have a tested load capacity of up to 150kg when correctly installed. For safety and performance, they must be installed by a qualified professional and fixed into a solid brick or masonry wall using appropriate fixings. Vaniti House accepts no responsibility for failure, damage, or injury resulting from incorrect installation or installation into unsuitable substrates.



BATHROOMS DESIGNED TO CARE

[www.vanitihouse.com](http://www.vanitihouse.com)

